



STANFORD UNIVERSITY LIBRARIES

# New Publishing Models: Persistence & Peer Review

8 April 2016

Fiesole Collection Development Retreat

Mimi Calter

Associate University Librarian & Chief of Staff

Stanford University Libraries

[mcalter@stanford.edu](mailto:mcalter@stanford.edu)

# Building Blocks & Business Models

- Stanford Digital Repository
- Spotlight
- Center for Interdisciplinary Digital Research (CIDR)
  
- SU Press Digital Publishing Initiative

# The Stanford Digital Repository

January 2016

1,102 collections

**204 million files**

**212 terabytes**

**articles, data sets, theses, photos,  
media, maps, manuscripts, books,  
and more...**

## SDR Deposit of the Week: Facilitating reproducibility

Many scientists are making the reproducibility of their research a much higher priority these days than they used to. But it's a time consuming task, which means that many are searching for tools and workflows to help facilitate their efforts.

Hatef Monajemi, a PhD student in Civil and Environmental Engineering, and his PhD advisor Professor David L. Donoho, have developed a new piece of software that can make reproducibility an easier goal to achieve. His new software is called Clusterjob (CJ). This software can be used to develop reproducible computational packages and make the generation of data for a research open-source software available on GitHub.

# Breadth

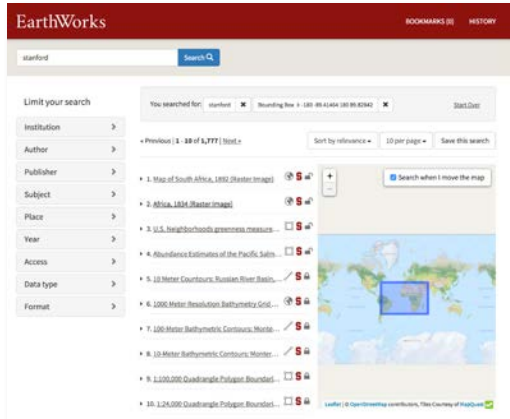

**EarthWorks**  
*Geospatial Data*

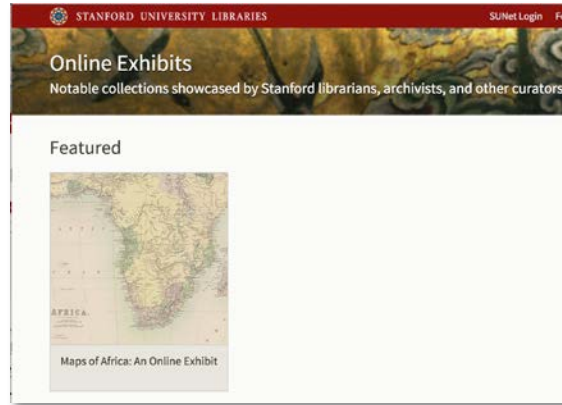

**Spotlight**  
*Exhibits*



**ArcLight**  
*Archives*

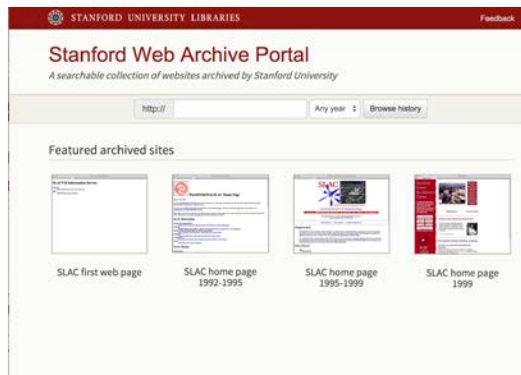

**Web Archiving**  
*Web captures*

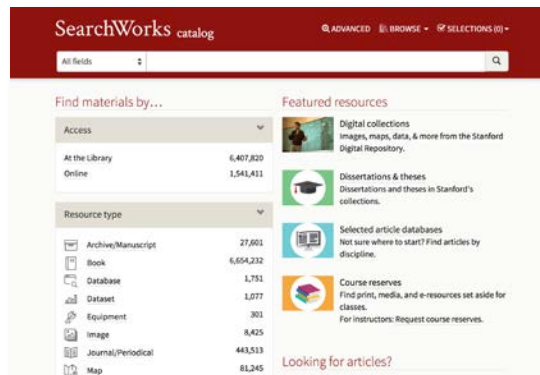

**SearchWorks**  
*Discovery*

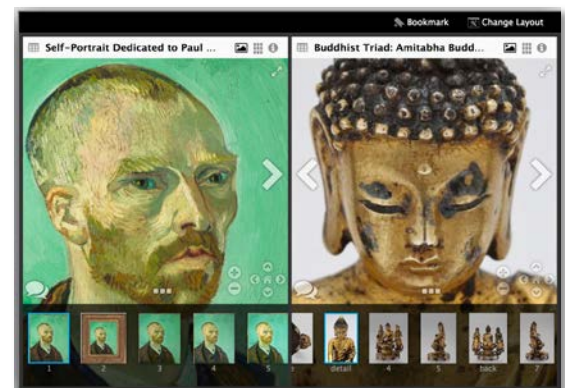

**Mirador**  
*Images*

## Evidence of Local Impact

***“I’m coming up on the end of an NSF-funded project and my advisor wants us to archive it. He said there are some new initiatives at Stanford related to such efforts.”***

***“We would like to put together a repository for data generated by our current NSF grant, as a way to satisfy the data management plans dictated by the NSF.”***

# Spotlight

- Simplify the process for creating online exhibits
- Leverage the metadata work done for SDR

Online Exhibits  
Notable collections showcase



The Bob Fitch Photography  
Archive

<https://exhibits.stanford.edu/>

# Spotlight

- Almost immediately taken on as a tool for scholarly communication
- Adopted by the Registrar for student portfolios

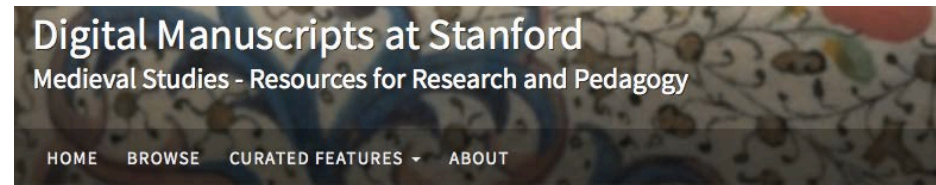

Home / Theodor Jung's Medieval...

Theodor Jung's Medieval Fragments

Theodor Jung's Medieval Fragments

DLCL122 - The Digital Middle Ages -  
Course Project

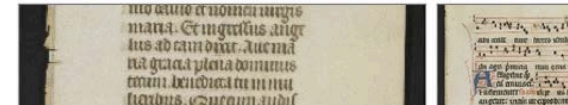

## DLCL122 - The Digital Middle Ages - Course Project

The participants in **DLCL122 in Winter Quarter 2016** produced a series of studies of a selection of Stanford manuscripts throughout the quarter by Liz Fischer, Christina Smith, and Laney McGlohon. Each study includes transcription: its creator.

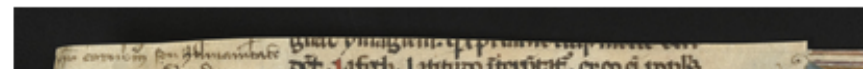

# What is CIDR?

## **Center for Interdisciplinary Digital Research**

Digital Humanities,  
Computational Social Sciences,  
& related digital library  
and digital scholarship services



# CIDR Service Profile

- Academic Technology Specialists
  - Technology specialists with deep subject-matter expertise embedded in departments
  - Liaison to library services
  
- Technology development
  - Competitive application process for support
  - Intensely collaborative, longer term digitally-enable research projects
  - Production of interactive scholarly works and publications.
  
- Centralized services
  - Data provisioning
  - Workshops & consultations

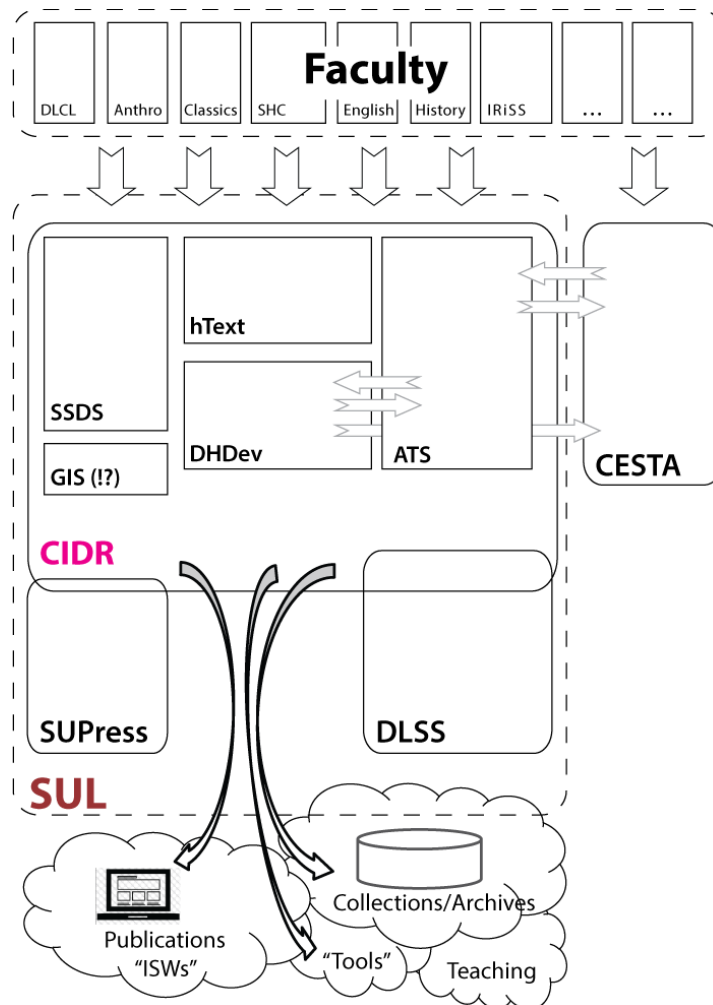

# Missing: Peer Review

- Journal and monograph publishing have established ecosystems of peer review and accreditation
  - Serve as benchmarks in the careers of scholars
- No parallel channels for “publication” or consistent “peer review” standards for digital projects.

# Publishing Digital Scholarship

- Publishing for interactive, digital-born scholarship
- Validated, peer-reviewed process
- Maintain true-to-form digital formats
- Mellon funding

introducing  
A DIGITAL PUBLISHING INITIATIVE  
FOR INTERACTIVE SCHOLARLY WORKS

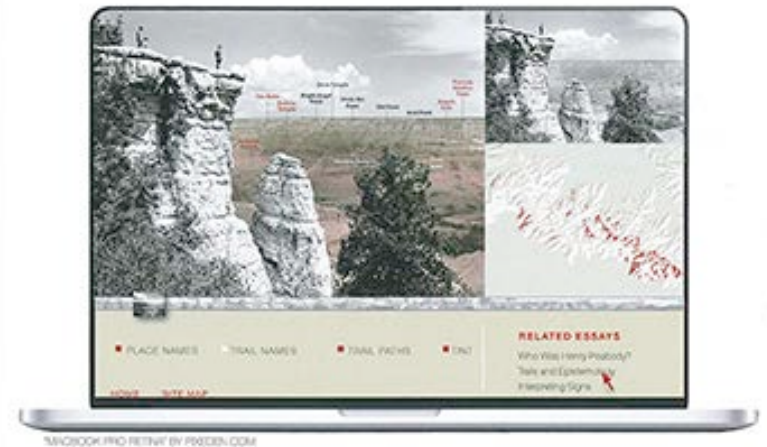

from  
STANFORD  
UNIVERSITY PRESS

# Publishing Digital Scholarship

"One goal for establishing a publishing methodology for interactive scholarly works is to provide a distribution channel that is held in the same high regard as the long-form monograph counterparts, . . . It is our intent to give scholars an opportunity to accumulate a digital publishing pedigree that provides the same consideration for hiring and tenure as traditional book publishing offers."



Alan Harvey, Director,  
Stanford University Press

# Program Objectives

- Establish interactive scholarly works as an integral part of a publishing program
  - Promote acceptance of the model within the academy's traditional assessment structure
- Develop a replicable business model
- Develop procedures that assure the persistence of published digital objects

# New Project Staff

- Digital Projects Editor

- Friederike Sundaram



- Digital Production Associate

- To be hired in the fall

*"As editors, we guide the development of any project, whether print or digital, by conducting peer review and honing the concept and structure of a project's argument. For digital projects, that means not only editing text, but also visual languages, and technological solutions."*

# Enchanting The Desert

- Dynamically links photographs, narratives, and GIS-enriched maps of the Grand Canyon
- Readers examine historical and cultural spaces of this landmark

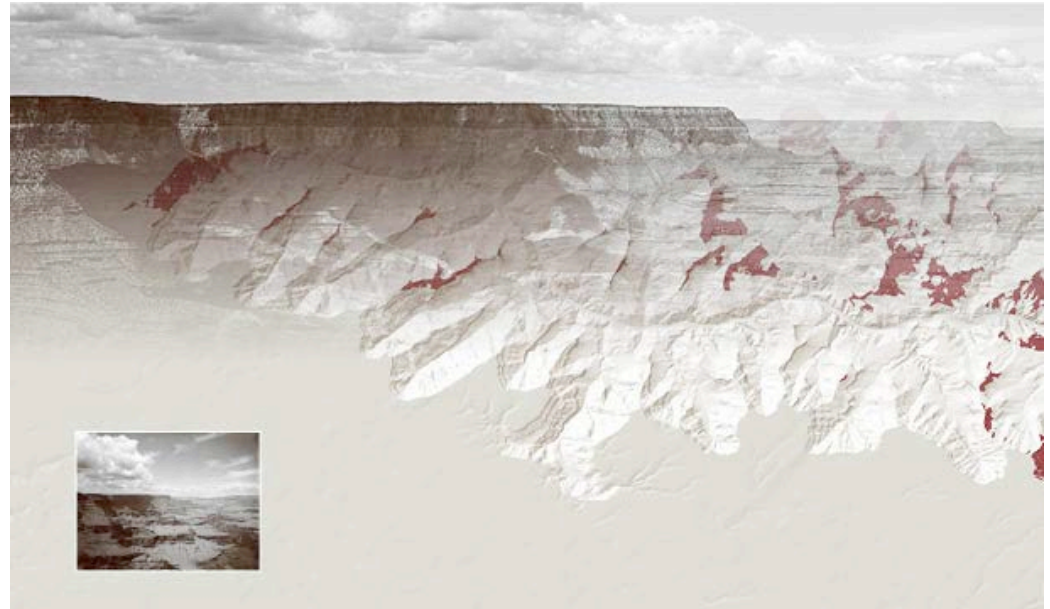

“Because of SUP’s prescient digital publishing initiative, the gap between what DH scholars are making and the established pathways of traditional academic distribution and accreditation is now much, much smaller.” – Nicholas Bauch (<http://stanfordpress.typepad.com/blog/2015/01/the-digital-pilot.html>)

## 2 | On Grand View Point

Home > Photo Modules > 2 | On Grand View Point

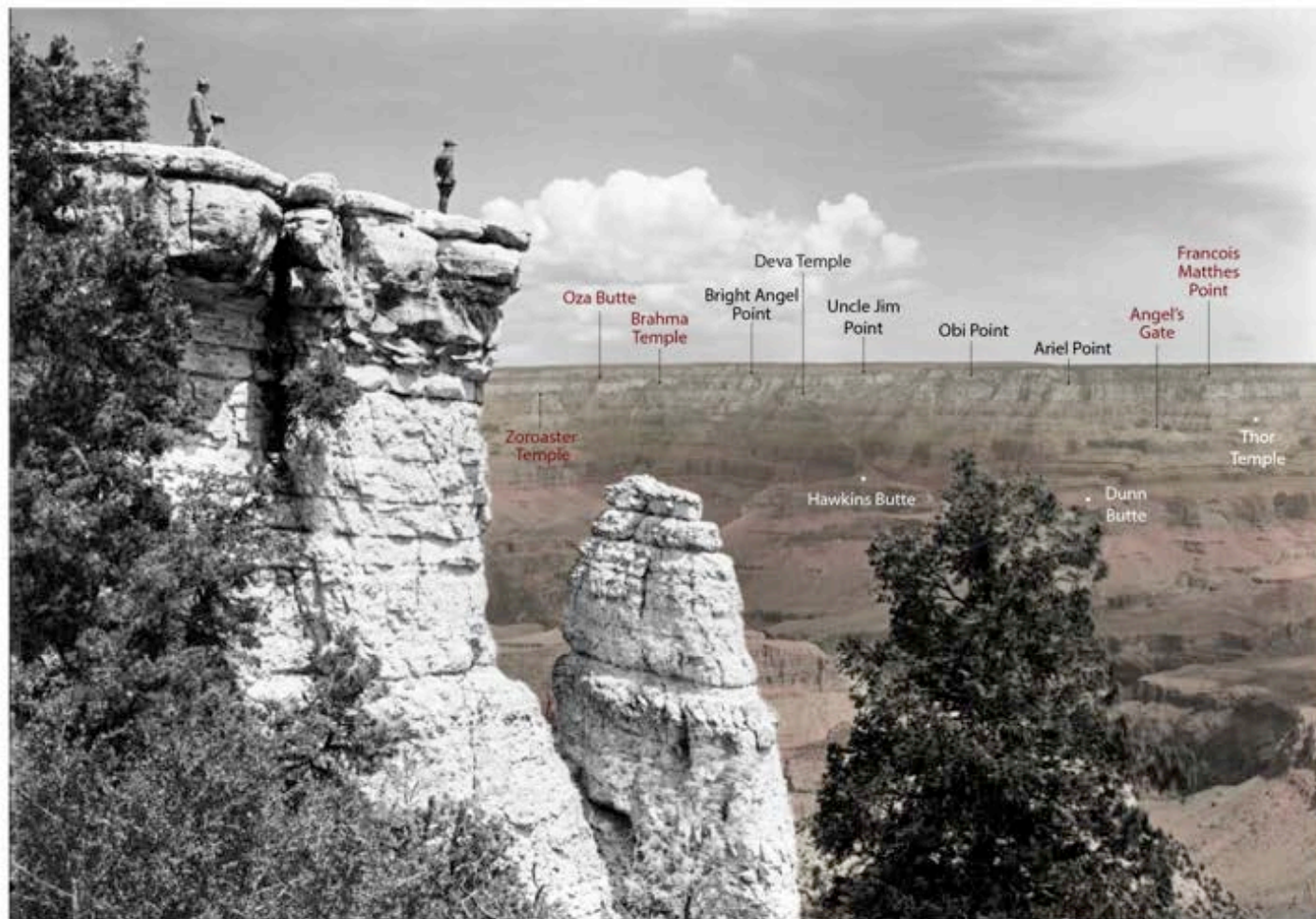

< Previous | Next >

### Augment This Photograph

Checking the boxes below will reveal additional image layers

Place Names

Trail Names

Trail Paths

Tinted Image



# The pipeline

- 2<sup>nd</sup> project has been signed
  - Built around a database of audio and video recordings of performances in Mahri, a language without a writing system
- 15 projects currently out for review
- Anticipate signing 1-2 additional projects during 2016
- Projecting 3 published projects in 2017; 5-10 in 2018

# Technical Support

- SU Press supports authors in significant ways
  - user interface design
  - consulting on software & plugins
  - copyediting
  - content development
- But not coding

# Platform Development

- Scholars are often looking for developers who can build platforms to support their arguments
- Platform development is part of the creative/research process for born digital works

# Technical Review

- Originally planned technical review of the finished product
- Projects are arriving in relatively early stages
- Shift to consulting and shadowing authors as they develop the project
  - Providing letters of support for grant proposals

# Business Model

- Focus on projects that are amenable to peer review
- For the moment, this remains effectively an open access publication
  - Potential to introduce fee-for-service approaches with future products

# Thank you!

Mimi Calter

Associate University Librarian & Chief of Staff

Stanford University Libraries

650-725-5813

[mcalter@stanford.edu](mailto:mcalter@stanford.edu)